



Test Certificate

Part Automated Disintegration Basket
(for 6 Tubes)

Part Number 23130-01

Serial Number SK6.7750 – SK6.7759

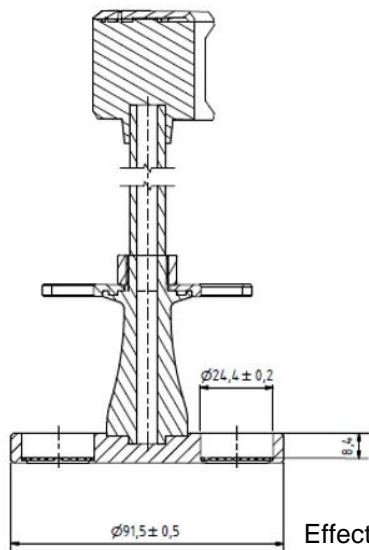

		USP / Ph.Eur	Tolerances
Dimensions	Bottom plate \varnothing	90.0 mm	± 2.0 mm
	Bottom thickness	6.75 mm	± 1.75 mm
	Distance to sieve	6.75 mm	± 1.75 mm
	6 Holes \varnothing	24 mm	± 2.00 mm
Material	PMMA, POM, PVC, PA		

USP / Ph.Eur conformity (acc. USP701 / Ph Eur 2.9.1) :

The accuracy of the above mentioned part dimensions have been examined. All relevant measurements are within tolerance and the factory acceptance test has passed.

The design of the basket-rack assembly may be varied somewhat, provided the specifications for the glass tubes and the screen mesh size are maintained. (separate Certificates for Glass tube #12514 and Sieve plate # 23440-01)

Aesch, 2024-04-26

Michael Schmidlin
SOTAX Quality Management
SOTAX AG | Nordring 1 | 4147 Aesch | Switzerland